



## Technical Data Sheet

### Luminosity Top View LED (Preliminary)

**45-21SUBC/S400-X8/TR8**

#### Features

- P-LCC-2 package.
- White package.
- Optical indicator.
- Colorless clear window.
- Wide viewing angle.
- Suitable for vapor-phase reflow, Infrared reflow and wave solder processes.
- Computable with automatic placement equipment.
- Available on tape and reel (8mm Tape).
- Pb-free.
- RoHS refer to SMD C Type test report.

#### Descriptions

- The 45-21 series is available in soft orange, green, blue and yellow. Due to the package design, the LED has wide viewing angle and optimized light coupling by inter reflector. This feature makes the ideal for light pipe application. The low current requirement makes this device ideal for portable equipment or any other application where power is at a premium.

#### Applications

- Automotive: backlighting in dashboard and switch.
- Telecommunication: indicator and backlighting in telephone and fax.
- Flat backlight for LCD, switch and symbol.
- Light pipe application.
- General use.

#### Device Selection Guide

Chip		Lens Color
Material	Emitted Color	
InGaN	Blue	Water Clear

**Package Outline Dimensions**

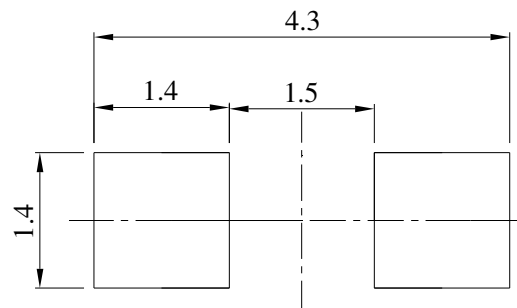
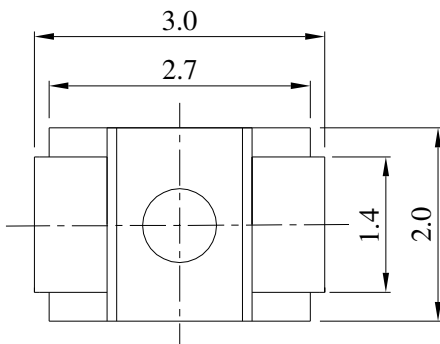
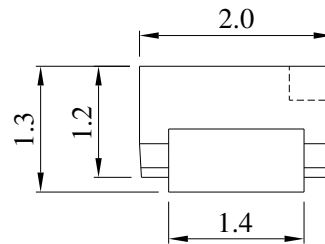
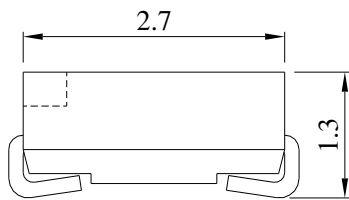
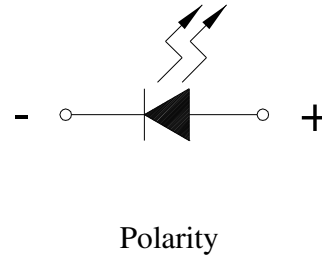
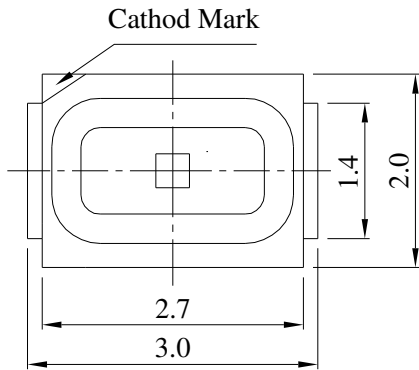

Recommended soldering pad design

- Notes:** 1.All dimensions are in millimeters.  
2.Tolerances unspecified are  $\pm 0.1$ mm.

**Absolute Maximum Ratings (Ta=25°C)**

Parameter	Symbol	Rating	Unit
Reverse Voltage	V <sub>R</sub>	5	V
Forward Current	I <sub>F</sub>	25	mA
Operating Temperature	T <sub>opr</sub>	-40 ~ +85	°C
Storage Temperature	T <sub>stg</sub>	-40 ~ +90	°C
Electrostatic Discharge(HBM)	ESD	150	V
Power Dissipation	P <sub>d</sub>	110	mW
Peak Forward Current (Duty 1/10 @1KHz)	I <sub>FP</sub>	100	mA
Soldering Temperature	T <sub>sol</sub>	Reflow Soldering : 260 °C for 10 sec. Hand Soldering : 350 °C for 3 sec.	

**Electro-Optical Characteristics (Ta=25°C)**

Parameter	Symbol	Min.	Typ.	Max.	Unit	Condition
Luminous Intensity	I <sub>v</sub>	90	180	-----	mcd	I <sub>F</sub> =20mA
Viewing Angle	2θ 1/2	-----	120	-----	deg	I <sub>F</sub> =20mA
Peak Wavelength	λ <sub>p</sub>	-----	468	-----	nm	I <sub>F</sub> =20mA
Dominant Wavelength	λ <sub>d</sub>	-----	470	-----	nm	I <sub>F</sub> =20mA
Spectrum Radiation Bandwidth	Δλ	-----	35	-----	nm	I <sub>F</sub> =20mA
Forward Voltage	V <sub>F</sub>	-----	3.3	3.7	V	I <sub>F</sub> =20mA
Reverse Current	I <sub>R</sub>	-----	-----	50	μA	V <sub>R</sub> =5V

**45-21SUBC/S400-X8/TR8**

**Typical Electro-Optical Characteristics Curves**

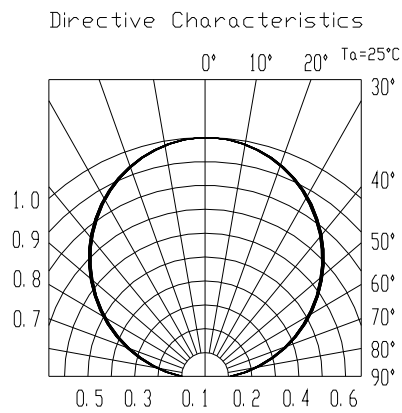
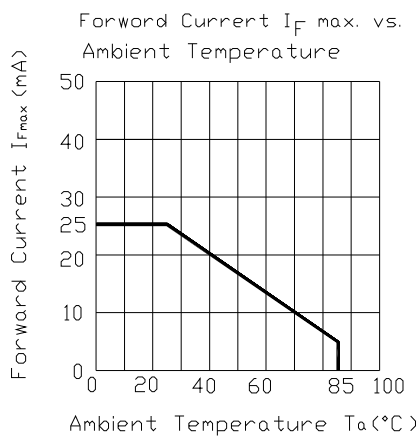
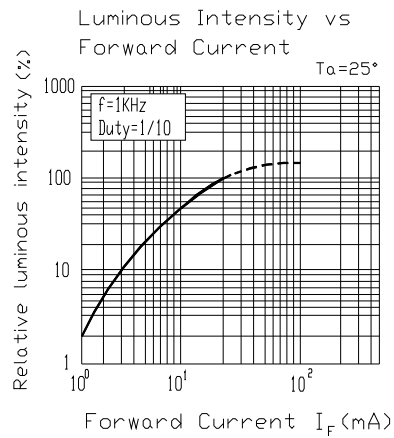
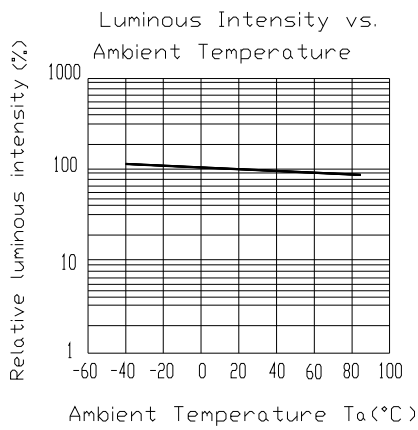
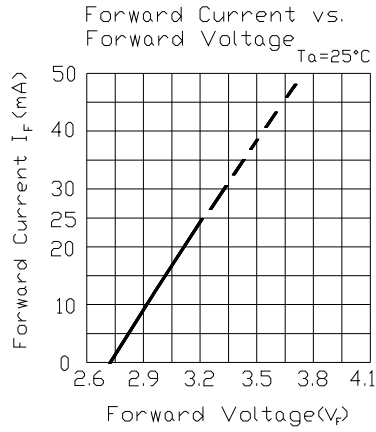
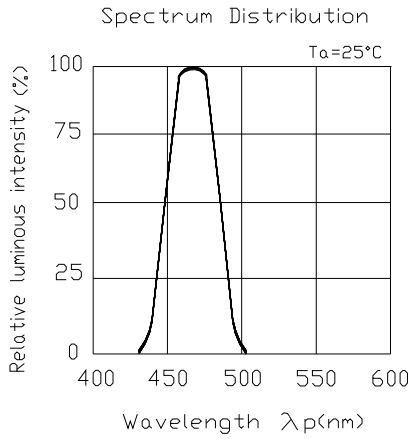



**45-21SUBC/S400-X8/TR8**

**Label explanation**

**CAT: Luminous Intensity Rank**

**HUE: Dom. Wavelength Rank**

**REF: Forward Voltage Rank**

EVERLIGHT		
CPN: XXXXXX		
P/N: XXXXXX		
		RoHS
XXXXXXXXXXXXXXXXXXXX		
QTY: XXXX		CAT:
		HUE:
LOT NO: XXXXXXXXXXXX		REF:
MADE IN TAIWAN		

**Reel Dimensions**

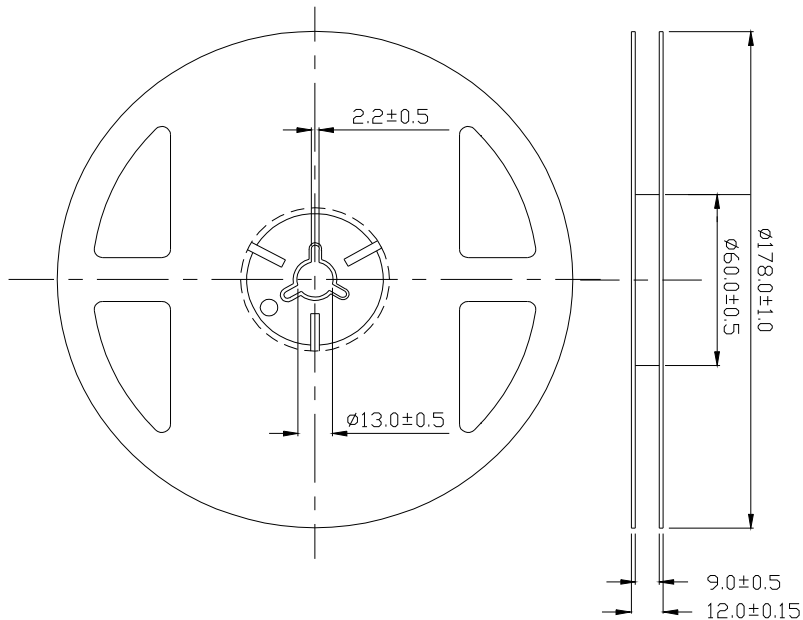

**Note:** The tolerances unless mentioned is  $\pm 0.1$ mm, Unit = mm

**Carrier Tape Dimensions: Loaded quantity 800 PCS per reel.**

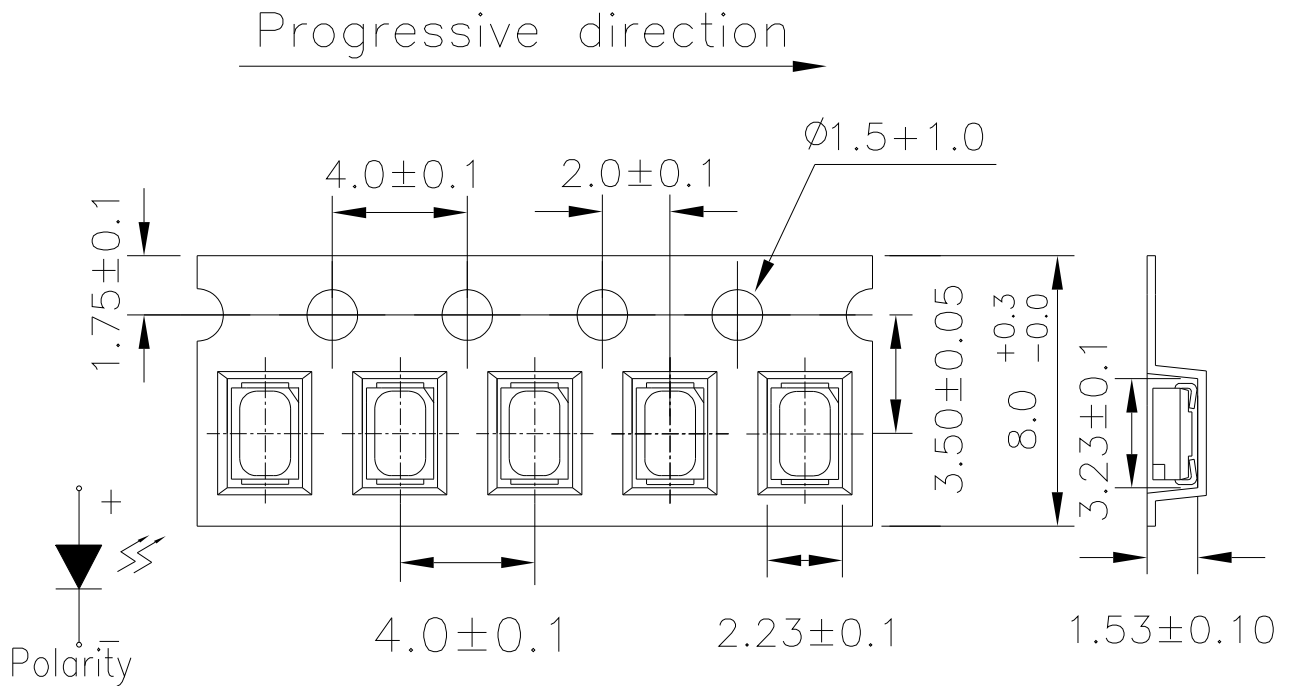

**Note: The tolerances unless mentioned is  $\pm 0.1\text{mm}$  Unit = mm**

**Moisture Resistant Packaging**

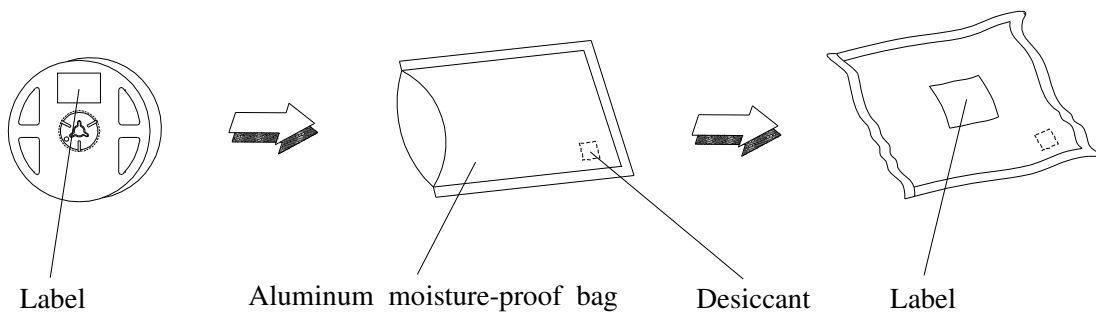

**Reliability Test Items And Conditions**

The reliability of products shall be satisfied with items listed below.

Confidence level : 90%

LTPD : 10%

No.	Items	Test Condition	Test Hours/Cycles	Sample Size	Ac/Re
1	Reflow Soldering	Temp. : 260°C±5°C Min. 5sec.	6 Min.	22 PCS.	0/1
2	Temperature Cycle	H : +100°C 15min ∫ 5 min L : -40°C 15min	300 Cycles	22 PCS.	0/1
3	Thermal Shock	H : +100°C 5min ∫ 10 sec L : -10°C 5min	300 Cycles	22 PCS.	0/1
4	High Temperature Storage	Temp. : 100°C	1000 Hrs.	22 PCS.	0/1
5	Low Temperature Storage	Temp. : -40°C	1000 Hrs.	22 PCS.	0/1
6	DC Operating Life	IF = 20 mA	1000 Hrs.	22 PCS.	0/1
7	High Temperature / High Humidity	85°C / 85%RH	1000 Hrs.	22 PCS.	0/1

**Precautions For Use**

1. Over-current-proof

Customer must apply resistors for protection, otherwise slight voltage shift will cause big current change ( Burn out will happen ).

2. Storage

- 2.1 Do not open moisture proof bag before the products are ready to use.
- 2.2 Before opening the package: The LEDs should be kept at 30°C or less and 90%RH or less.
- 2.3 After opening the package: The LED's floor life is 1 year under 30 deg C or less and 60% RH or less.  
If unused LEDs remain, it should be stored in moisture proof packages.
- 2.4 If the moisture absorbent material (silica gel) has faded away or the LEDs have exceeded the storage time, baking treatment should be performed using the following conditions.  
Baking treatment : 60±5°C for 24 hours.

3. Soldering Condition

3.1 Pb-free solder temperature profile

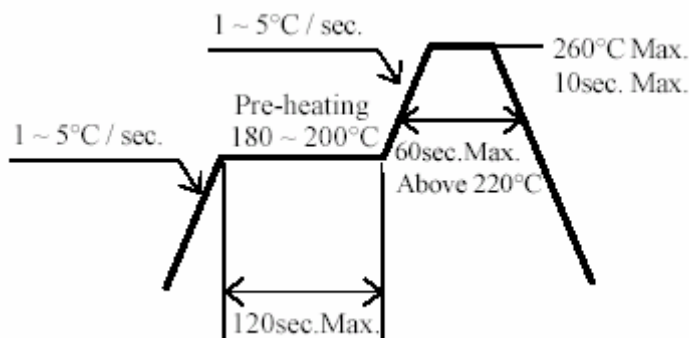

- 3.2 Reflow soldering should not be done more than two times.
- 3.3 When soldering, do not put stress on the LEDs during heating.
- 3.4 After soldering, do not warp the circuit board.

4. Soldering Iron

Each terminal is to go to the tip of soldering iron temperature less than 350°C for 3 seconds within once in less than the soldering iron capacity 25W. Leave two seconds and more intervals, and do soldering of each terminal. Be careful because the damage of the product is often started at the time of the hand solder.

### 5.Repairing

Repair should not be done after the LEDs have been soldered. When repairing is unavoidable, a double-head soldering iron should be used (as below figure). It should be confirmed beforehand whether the characteristics of the LEDs will or will not be damaged by repairing.

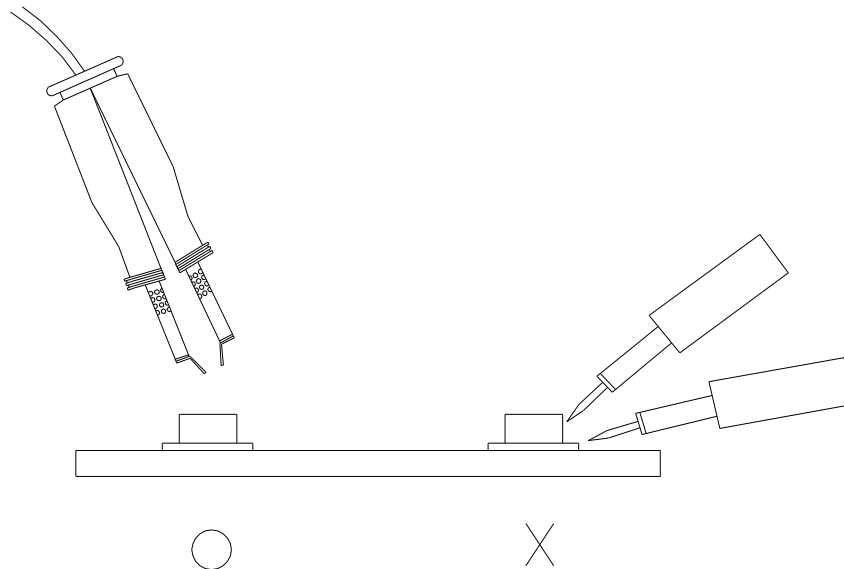

**EVERLIGHT ELECTRONICS CO., LTD.**  
Office: No 25, Lane 76, Sec 3, Chung Yang Rd,  
Tucheng, Taipei 236, Taiwan, R.O.C

Tel: 886-2-2267-2000, 2267-9936  
Fax: 886-2267-6244, 2267-6189, 2267-6306  
<http://www.everlight.com>